

150mΩ ,Adjustable, Fast Response Current Limited Power Switches

● Features

- Input Voltage Range: 2.4V to 5.5V
- Programmable Over-Current Threshold
- Fast Transient Response:
 - 400ns Response to Short Circuit
- Low Quiescent Current
 - 9μA Typical
 - 1μA Max with Switch Off
- 150m Typical $R_{DS(ON)}$
- Only 2.5V Needed for ON/OFF Control
- Under-Voltage Lockout
- Thermal Shutdown
- 4kV ESD Rating
- 5-Pin SOT23
- Temperature Range: -40°C to +85°C

● Applications

- Hot Swap Supplies
- Notebook Computers
- Peripheral Ports
- Personal Communication Devices

● General Description

The FS9001R Smart Switch is a current limited P-channel MOSFET power switch designed for high-side load switching applications. This switch operates with inputs ranging from 2.4V to 5.5V, making it ideal for both 3V and 5V systems. An integrated current-limiting circuit protects the input supply against large currents which may cause the supply to fall out of regulation. The FS9001R is also protected from thermal overload which limits power dissipation and junction temperatures. It can be used to control loads that require up to 1A. Current limit threshold is programmed with a resistor from SET to ground. The quiescent supply current is typically a low 9μA. In shutdown mode, the supply current decreases to less than 1μA. The FS9001R is available in a Pb-free 5-pin SOT23 package and is specified over the -40°C to +85°C temperature range.

● Package Information & Functional Block Diagram

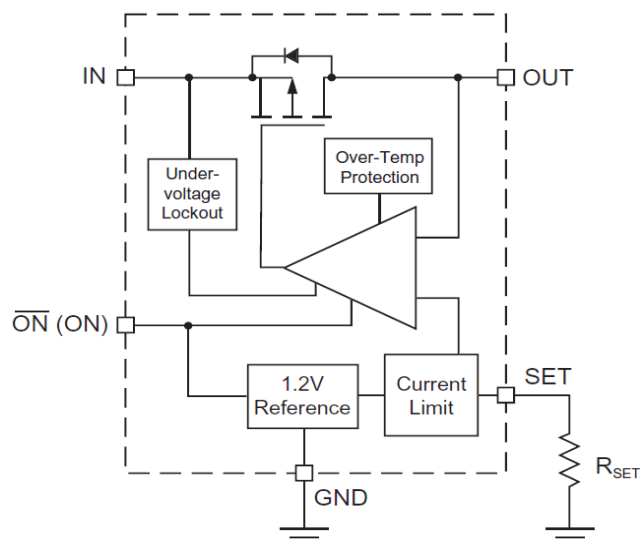
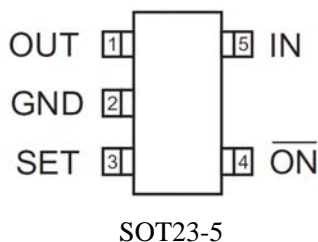

FS9001R

● Absolute Maximum Ratings

Parameter	Rating	Unit
IN Voltage	-0.3 to 7	V
EN, SET, OUT Voltage	-0.3 to $V_{IN} + 0.3$	V
Maxim Continuous Switch Current	3	A
Junction to Ambient Thermal Resistance (θ_{JA})	125	°C/W
Operating Junction Temperature	-40 to 85	°C
Storage Temperature	-65 to 150	°C
Lead Temperature (Soldering, 10 sec)	300	°C
ESD	4000	V

● Electrical Characteristics

$V_{IN} = 5V$, $T_a = 25^\circ C$, unless otherwise specified

Symbol	Parameter	Test Conditions	Min	Typ.	Max	Unit
V_{IN}	Input Voltage Range		2.4		5.5	V
V_{UVLO}	Input U_{VLO}		1.8		2.4	V
I_{SHDN}	Input Shutdown Quiescent Current	Disabled, $V_{EN}=0V$, OUT floating or shorted to ground		0.01	1	μA
I_Q	Input Quiescent Current	Enabled, $V_{EN}=V_{IN}$, $I_{OUT} = 0$		7	25	μA
$R_{DS(ON)}$	Switch on-resistance	$V_{IN} = 5V$, $T_A=25^\circ C$		150		m Ω
		$V_{IN} = 3V$, $T_A=25^\circ C$		200		m Ω
I_{LMT}	Current Limit	$R_{SET}=7.2k\Omega$	0.75	1	1.25	A
V_{IL}	EN Input Logic Low Voltage				0.8	V
V_{IH}	EN Input Logic High Voltage		2.0			V
I_{LEAK}	Output Leakage Current	EN=Inactive, $R_{LOAD} = 0$		0.5	10	μA
T_{RESP}	Current Limit Response Time	$V_{IN}=5V$		50		μS
T_{SD}	Thermal Shutdown Protection			125		°C
T_{SD}	Thermal Shutdown Hysteresis			10		°C

● Typical Performance Characteristics

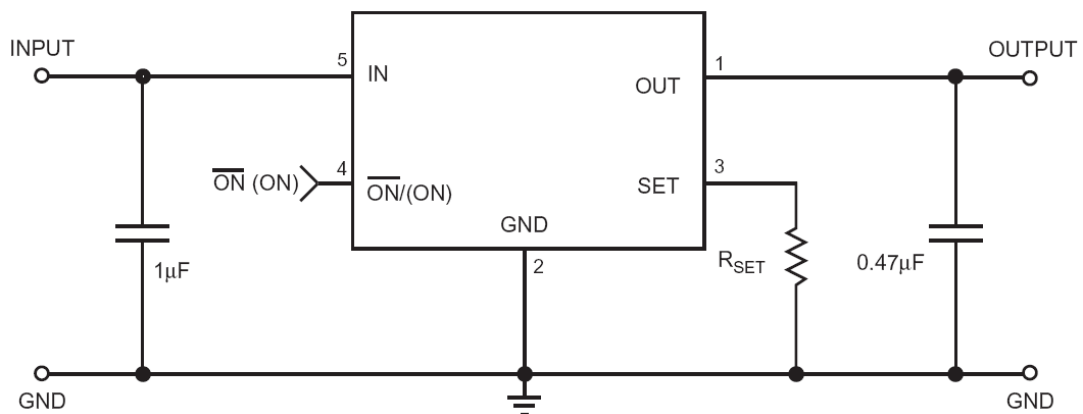

FS9001R

- Typical Performance Characteristics

Quiescent Current vs. Temperature

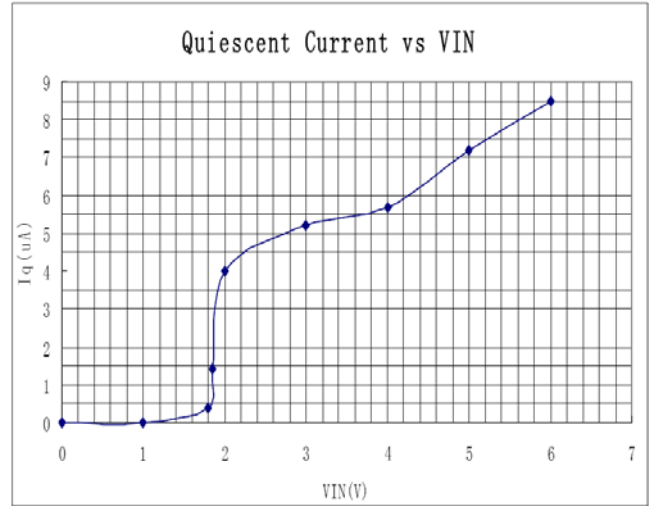
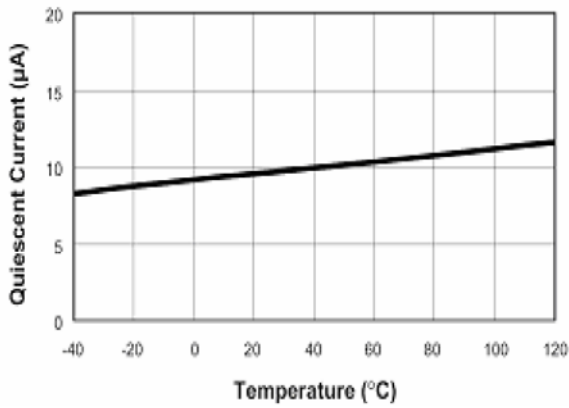

Off-Supply Current vs. Temperature

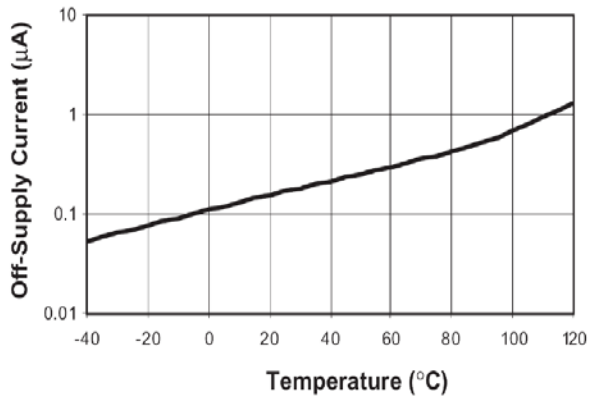

Off-Switch Current vs. Temperature

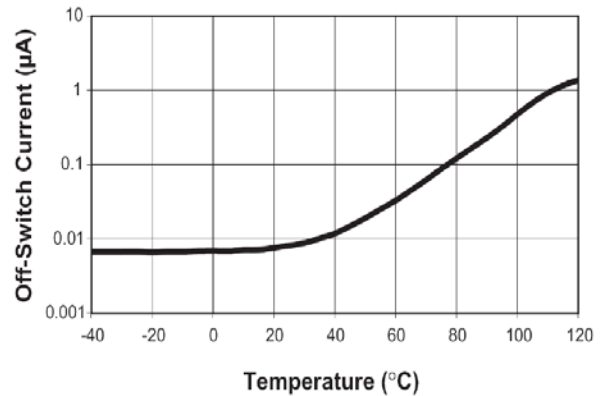

Turn-On vs. Temperature
($R_{LOAD} = 10\Omega$; $C_{LOAD} = 0.47\mu F$)

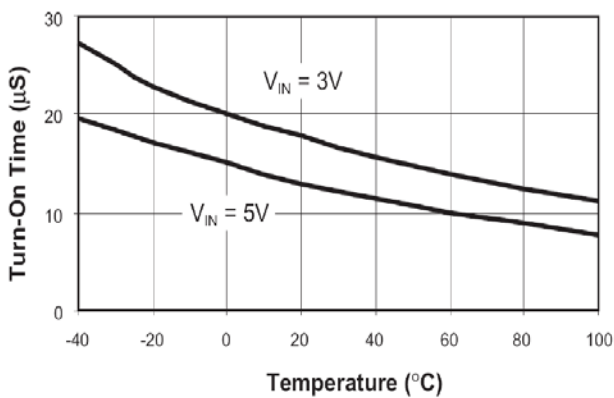

Turn-Off vs. Temperature
($R_{LOAD} = 10\Omega$; $C_{LOAD} = 0.47\mu F$)

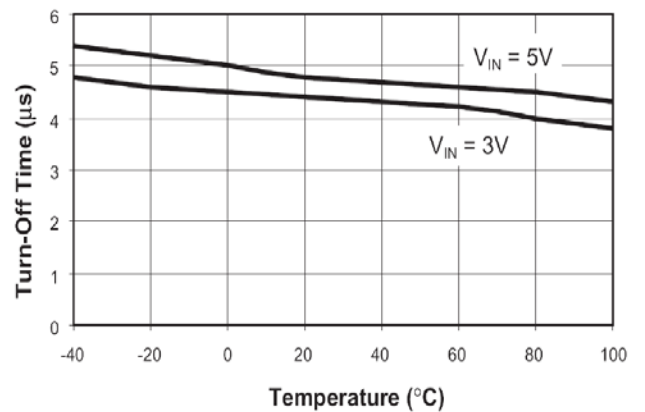

FS9001R

VIN=5V, RL=10 Ω, COU=0.47uF (Channel13=VEN, Channel12=V0)

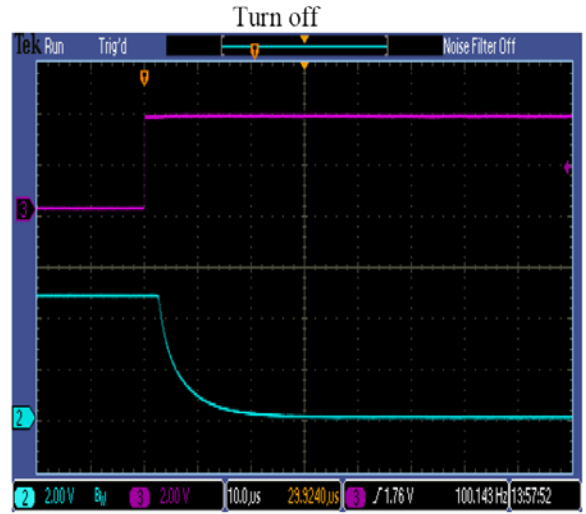
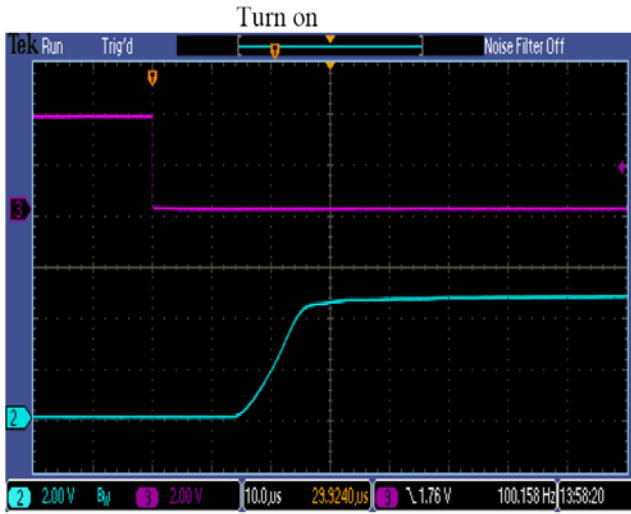

Short circuit to GND

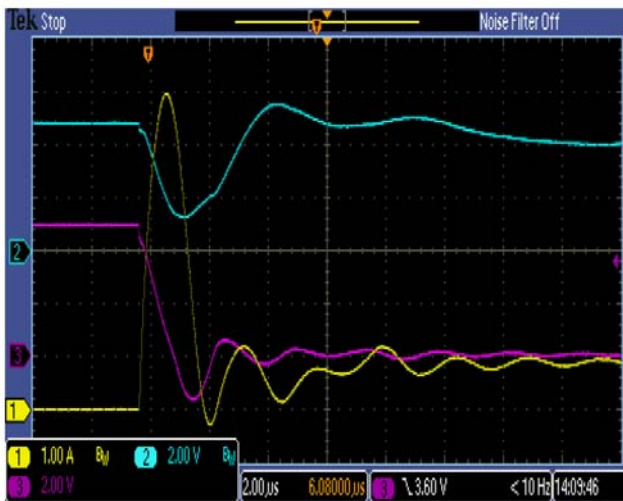

Channel1=IO,Channel2=Vin,Channel3=Vo

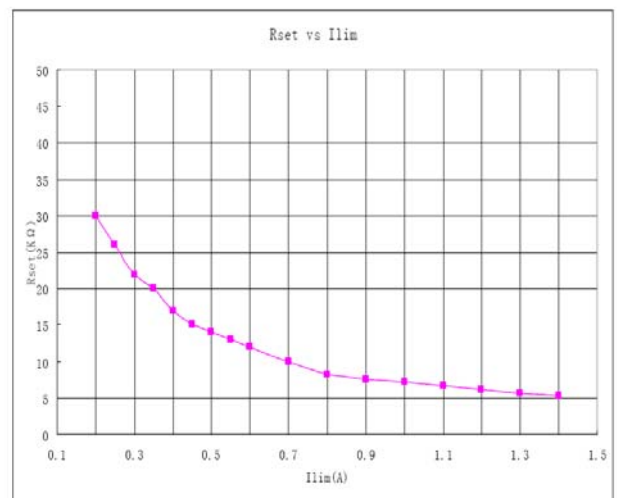
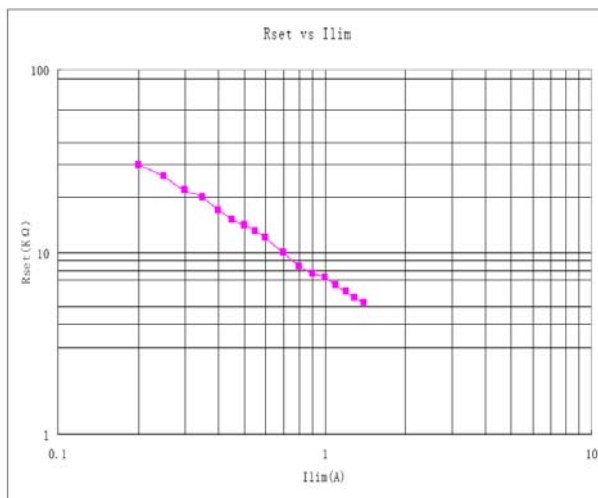
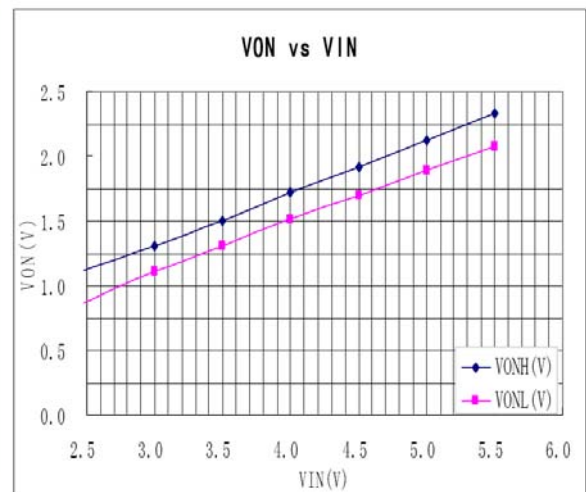

Setting Current Limit

In most applications, the variation in I_{LIM} must be taken into account when determining R_{SET} . The I_{LIM} variation is due to processing variations from part to part, as well as variations in the voltages at IN and OUT, plus the operating temperature. These three factors add up to a $\pm 25\%$ tolerance. Figure 1 illustrates a cold device with a statistically higher current limit and a hot device with a statistically lower current limit, both with R_{SET} equal to $10k\Omega$. While the chart, " R_{SET} vs. I_{LIM} " indicates an I_{LIM} of $0.7A$ with an R_{SET} of $10k\Omega$, this figure shows that the actual current limit will be at least $0.525A$ and no greater than $0.880A$.

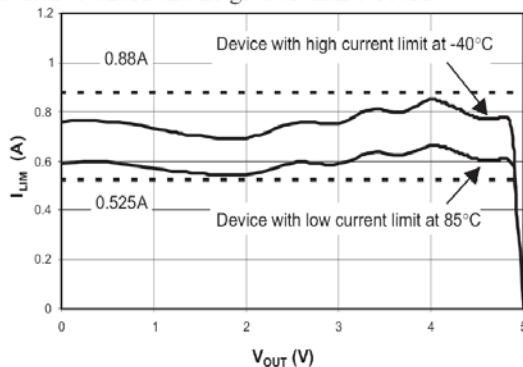

Figure 1: Current Limit Using $10k\Omega$.

To determine R_{SET} , start with the maximum current drawn by the load and multiply it by 1.33 (typical $I_{LIM} = \text{minimum } I_{LIM} / 0.75$). This is the typical current limit value. Next, refer to " R_{SET} vs. I_{LIM} " and find the R_{SET} that corresponds to the typical current limit value. Choose the largest resistor available that is less than or equal to it. For greater precision, the value of R_{SET} may also be calculated using the $I_{LIM} R_{SET}$ product found in the chart " R_{SET} Coefficient vs. I_{LIM} ". The maximum current is derived by multiplying the typical current for the chosen R_{SET} in the chart by 1.25. A few standard resistor values are listed in the table "Current Limit R_{SET} Values."

Current Limit R_{SET} Values

RSET (kΩ)	Current Limit Typ (mA)	Device Will Not Current Limit Below (mA)	Device Always Current Limits Below (mA)
30	200	150	250
26	250	188	313
22	300	225	375
20	350	263	438
17	400	300	500
15	450	338	563
14	500	375	625

13	550	413	688
12	600	450	750
10	700	525	875
8.3	800	600	1000
7.8	900	675	1125
7.2	1000	750	1250
6.6	1100	825	1375
6.1	1200	900	1500
5.6	1300	975	1625
5.3	1400	1050	1750

Example: A USB port requires $0.5A$. $0.5A$ multiplied by 1.33 is $0.665A$. From the chart named " R_{SET} vs. I_{LIM} " R_{SET} should be less than $12k\Omega$. $10k\Omega$ is a standard value that is a little less than $12k\Omega$ but very close. The chart reads approximately $0.700A$ as a typical I_{LIM} value for $10k\Omega$. Multiplying $0.700A$ by 0.75 and 1.25 shows that the FS9001R will limit the load current to greater than $0.525A$ but less than $0.875A$.

Operation in Current Limit

When a heavy load is applied to the output of the FS9001R, the load current is limited to the value of I_{LIM} determined by R_{SET} . See Figure 2, "Overload Operation." Since the load is demanding more current than I_{LIM} , the voltage at the output drops. This causes the FS9001R to dissipate a larger than normal quantity of power, and its die temperature to increase. When the die temperature exceeds an over-temperature limit, the FS9001R will shut down until it has cooled sufficiently, at which point it will startup again. The FS9001R will continue to cycle on and off until the load is removed, power is removed, or until a logic high level is applied to ON.

Enable Input

In many systems, power planes are controlled by integrated circuits which run at lower voltages than the power plane itself. The enable input ON of the FS9001R has low and high threshold voltages that accommodate this condition. The threshold voltages are compatible with 5V TTL and 2.5V to 5V CMOS.

Reverse Voltage

The FS9001R is designed to control current flowing from IN to OUT. If a voltage is applied to OUT which is greater than the voltage on IN, large currents may flow. This could cause damage to the FS9001R.

- Package Information

SOT-23-5L PACKAGE OUTLINE DIMENSIONS

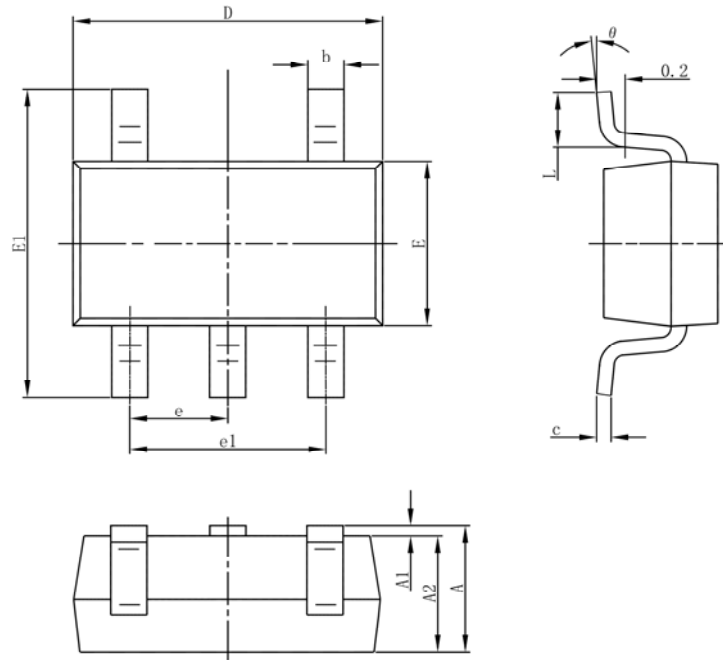

Symbol	Dimensions In Millimeters		Dimensions In Inches	
	Min	Max	Min	Max
A	1.050	1.250	0.041	0.049
A1	0.000	0.100	0.000	0.004
A2	1.050	1.150	0.041	0.045
b	0.300	0.500	0.012	0.020
c	0.100	0.200	0.004	0.008
D	2.820	3.020	0.111	0.119
E	1.500	1.700	0.059	0.067
E1	2.650	2.950	0.104	0.116
e	0.950(BSC)		0.037(BSC)	
e1	1.800	2.000	0.071	0.079
L	0.300	0.600	0.012	0.024
θ	0°	8°	0°	8°