

2A, 18V, 450 kHz Synchronous Rectified Step-Down

● Features

- 2A Output Current
- Wide 4.75V to 18V Operating Input Range
- Integrated 130mΩ Power MOSFET Switches
- Output Adjustable from 0.923V to 15V
- Up to 95% Efficiency
- Programmable Soft-Start
- Stable with Low ESR Ceramic Output Capacitors
- Fixed 450KHz Frequency
- Cycle-by-Cycle Over Current Protection
- Input Under Voltage Lockout

● Applications

- TFT LCD Monitors
- Portable DVDs, Headphones, MP3 Players, etc.
- Car-Powered or Battery-Powered Equipment
- Set-Top Boxes
- Telecom Power Supplies
- DSL and Cable Modems and Routers

● Typical Application

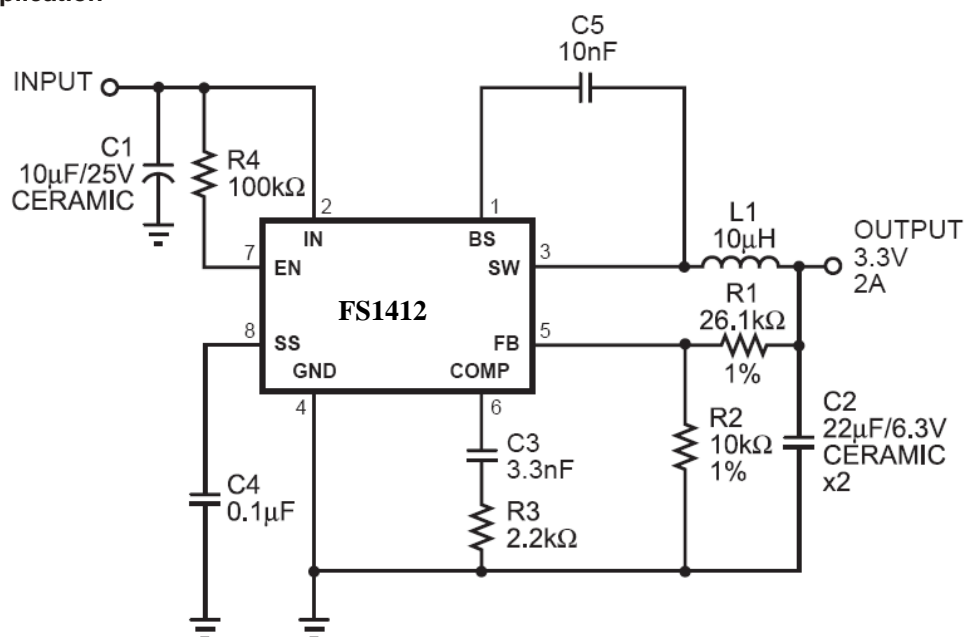

● General Description

The FS1412 is a monolithic synchronous buck regulator. The device integrates 100mΩ MOSFETS that provide 2A continuous load current over a wide operating input voltage of 4.75V to 18V. Current mode control provides fast transient response and cycle-by-cycle current limit. An adjustable soft-start prevents inrush current at turn-on. In shutdown mode, the supply current drops below 1 µA. This device, available in an 8-pin SOIC package, provides a very compact system solution with minimal reliance on external components.

Package Information

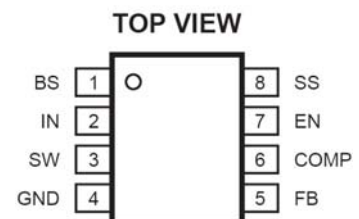

FS1412

● **Absolute Maximum Ratings @ $T_A=25^{\circ}\text{C}$** unless otherwise noted

PARAMETER	SYMBOL	TYP
Supply Voltage	VIN	-0.3V to +20V
Switch Node Voltage	VSW	21V
Boost Voltage	VBS	VSW - 0.3V to VSW + 6V
All Other Pins		-0.3V to +6V
Junction Temperature.		150°C
Lead Temperature		260°C
Storage Temperature		-65°C to +150°C
Recommended Operating Conditions		
Input Voltage	VIN	4.75V to 18V
Output Voltage	VOUT	0.923V to 15V
Ambient Operating Temperature		-40°C to +85°C
Thermal Resistance (3)	$\theta_{JA} \theta_{JC}$	90..... 45... ° C/W

● **Electrical Characteristics @ $T_A=25^{\circ}\text{C}$** unless otherwise noted

VIN = 12V, TA = +25°C, unless otherwise noted.

Parameter	Symbol	Condition	Min	Typ	Max	Units
Shutdown Supply Current		VEN = 0V		1	3.0	μA
Supply Current		VEN = 2.0V; VFB = 1.0V		1.3	1.5	mA
Feedback Voltage	VFB	4.75V \leq VIN \leq 18V	0.900	0.923	0.946	V
Feedback Overvoltage Threshold				1.1		V
Error Amplifier Voltage Gain (4)	AEA			400		V/V
Error Amplifier Transconductance	GEA	$\Delta \text{IC} = \pm 10\mu\text{A}$		800		$\mu\text{A/V}$
High-Side Switch On Resistance (4)	RDS(ON)1			130		m Ω
Low-Side Switch On Resistance (4)	RDS(ON)2			130		m Ω
High-Side Switch Leakage Current		VEN = 0V, VSW = 0V			10	μA
Upper Switch Current Limit		Minimum Duty Cycle	2.4	3.4		A
Lower Switch Current Limit		From Drain to Source		1.1		A
COMP to Current Sense Transconductance	GCS			3.5		A/V
Oscillation Frequency	Fosc1			450		KHz
Short Circuit Oscillation Frequency	Fosc2	VFB = 0V		100		KHz
Maximum Duty Cycle	DMAX	VFB = 1.0V		90		%
Minimum On Time (4)				220		ns
EN Shutdown Threshold Voltage		VEN Rising	1.1	1.5	2.0	V
EN Shutdown Threshold Voltage Hysteresis				210		mV
EN Lockout Threshold Voltage			2.2	2.5	2.7	V
EN Lockout Hysteresis				210		mV

FS1412

Input Under Voltage Lockout Threshold		VIN Rising	3.80	4.10	4.40	V
Hysteresis				210		mV
Soft-Start Current		VSS = 0V		6		μA
Soft-Start Period		CSS = 0.1μF		15		ms
Thermal Shutdown (4)				160		°C

Note: 4) Guaranteed by design, not tested.

● Typical Performance Characteristics

(VIN = 12V, VO = 3.3V, L = 10μH, C1 = 10μF, C2 = 22μF, TA = +25°C, unless otherwise noted.)

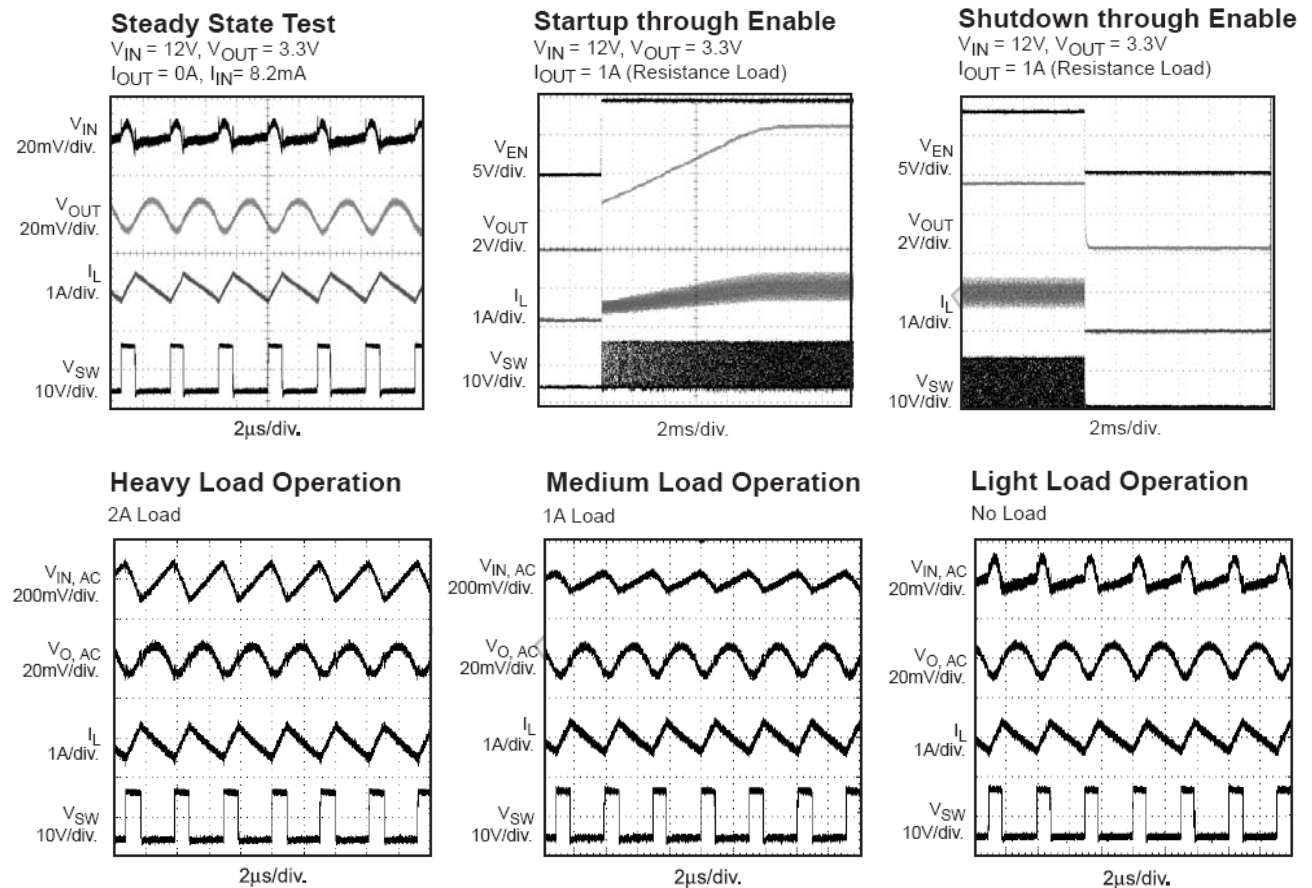

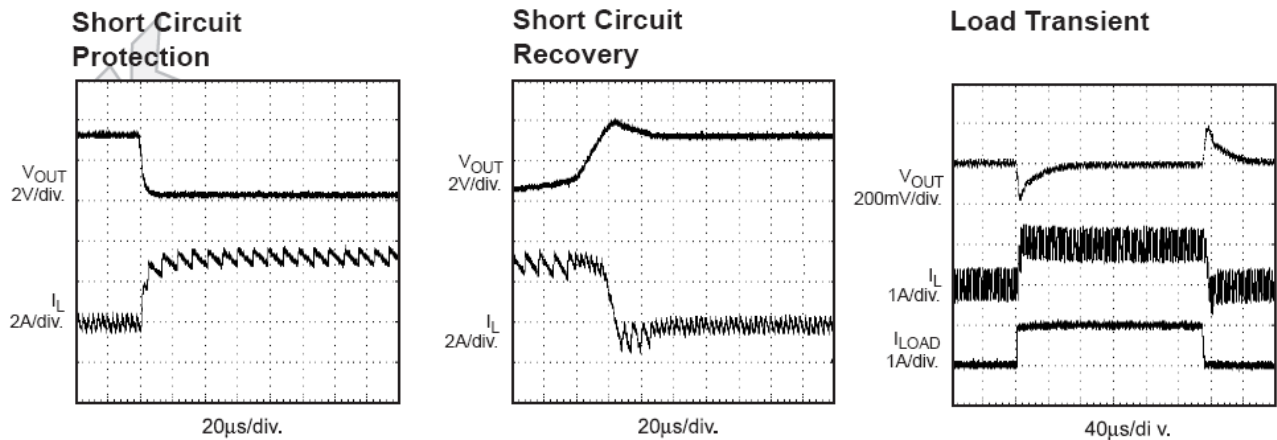

OPERATION

FUNCTIONAL DESCRIPTION

The FS1412 is a synchronous rectified, current-mode, step-down regulator. It regulates input voltages from 4.75V to 18V down to an output voltage as low as 0.923V, and supplies up to 2A of load current.

The FS1412 uses current-mode control to regulate the output voltage. The output voltage is measured at FB through a resistive voltage divider and amplified through the internal transconductance error amplifier. The voltage at the COMP pin is compared to the switch current measured internally to control the output voltage.

The converter uses internal N-Channel MOSFET switches to step-down the input voltage to the regulated output voltage. Since the high side MOSFET requires a gate voltage greater than the input voltage, a boost capacitor connected between SW and BS is needed to drive the high side gate. The boost capacitor is charged from the internal 5V rail when SW is low.

When the FS1412 FB pin exceeds 20% of the nominal regulation voltage of 0.923V, the over voltage comparator is tripped and the COMP pin and the SS pin are discharged to GND, forcing the high-side switch off.

FS1412

- Package Information**

Physical Dimensions inches(millimeters) unless otherwise noted

SOP8

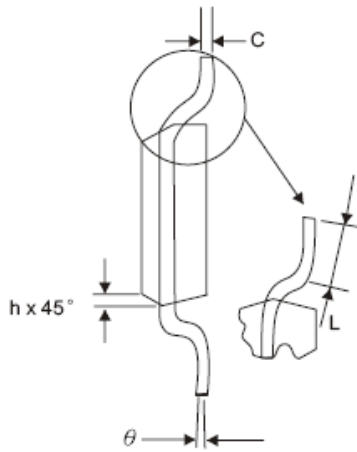
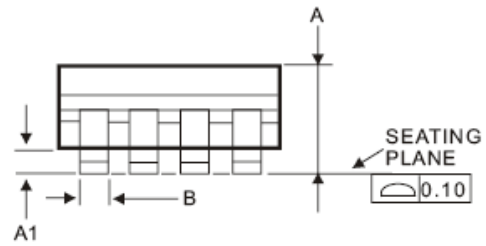
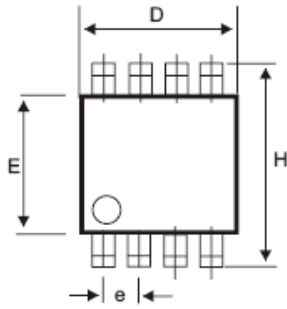

DIM	MILLIMETERS	
	MIN	MAX
A	1.35	1.75
A1	0.10	0.25
B	0.35	0.49
C	0.18	0.25
D	4.80	5.00
E	3.80	4.00
e	1.27 BSC	
H	5.80	6.20
h	0.25	0.50
L	0.40	1.25
θ	0°	7°